

# Partdrawing for GA023GM201 - Haakse slijper

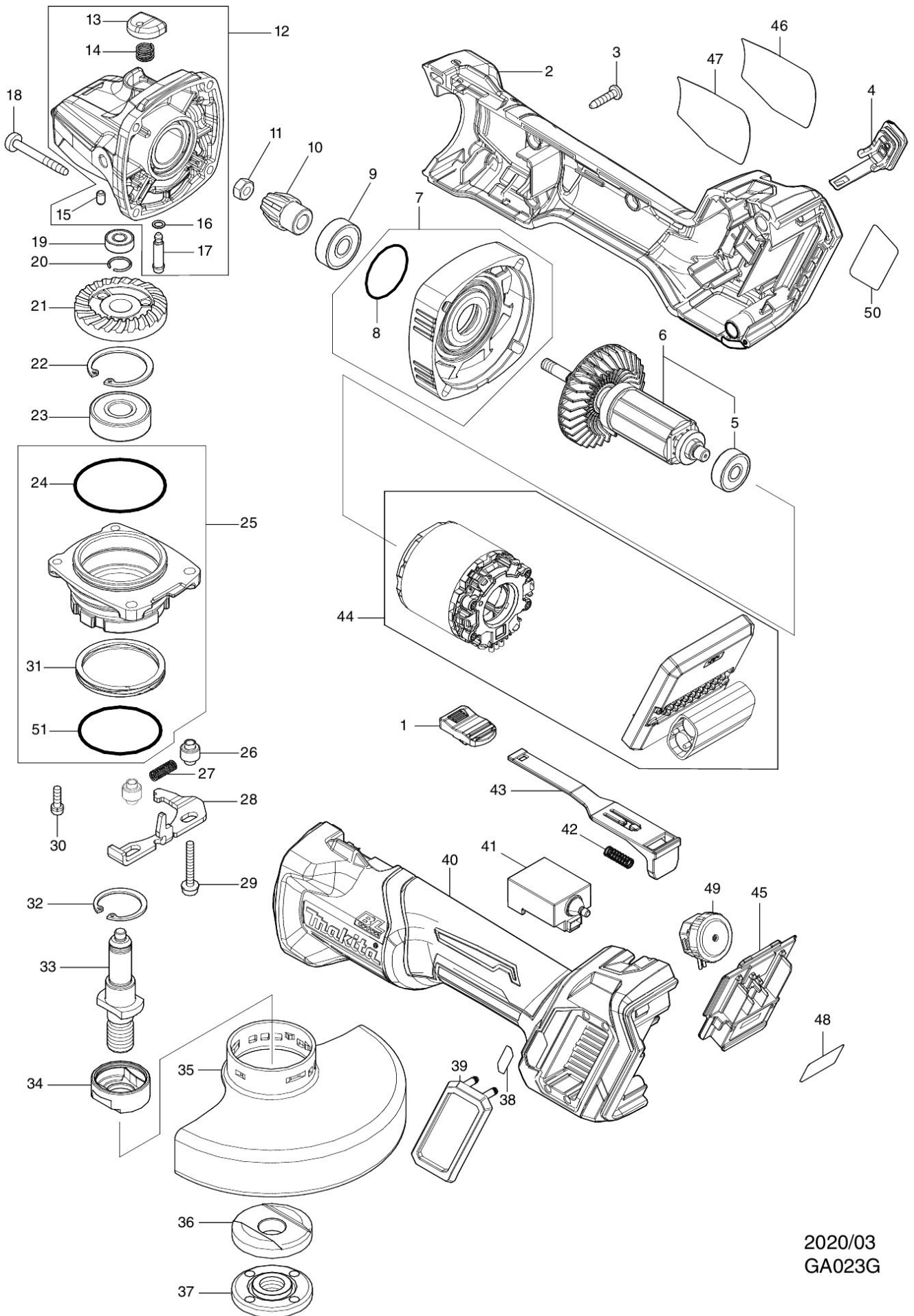

2020/03  
GA023G