

# Partdrawing for GA023GZ - Haakse slijper

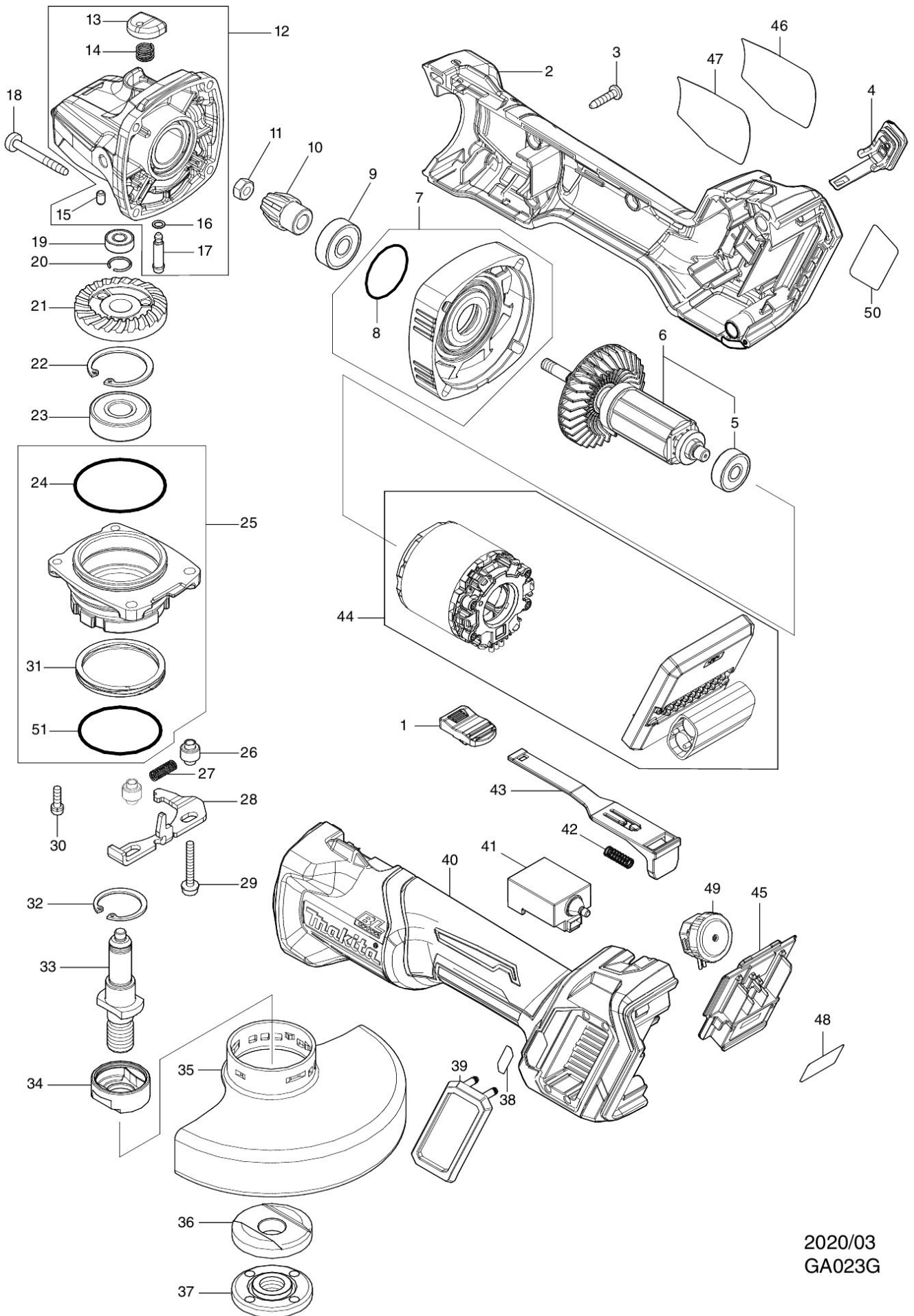

2020/03  
GA023G