

Partdrawing for GA026GM201 - Haakse slijper

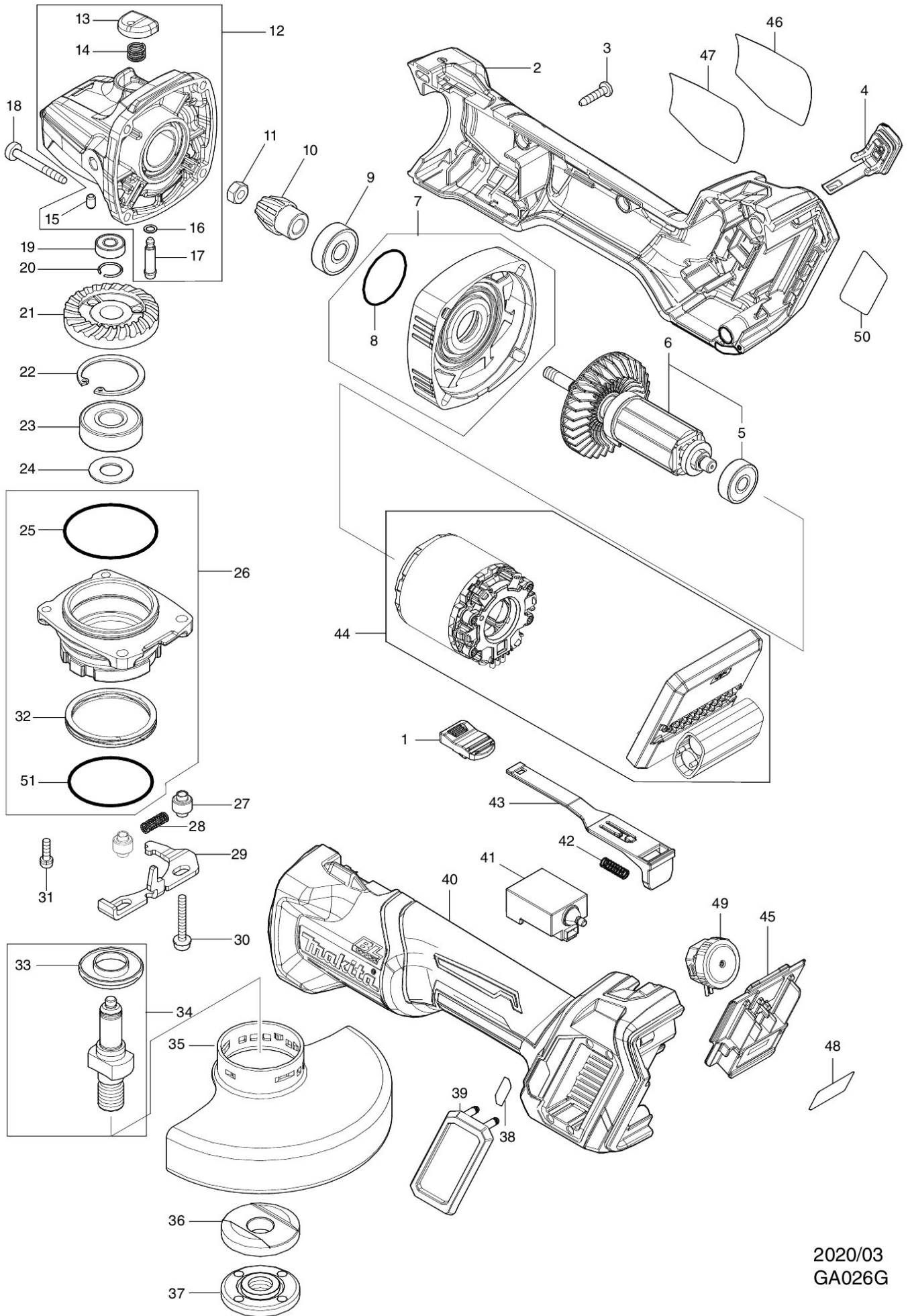

2020/03
GA026G