

Partdrawing for DTDA100Z - Slagschroevendraaier

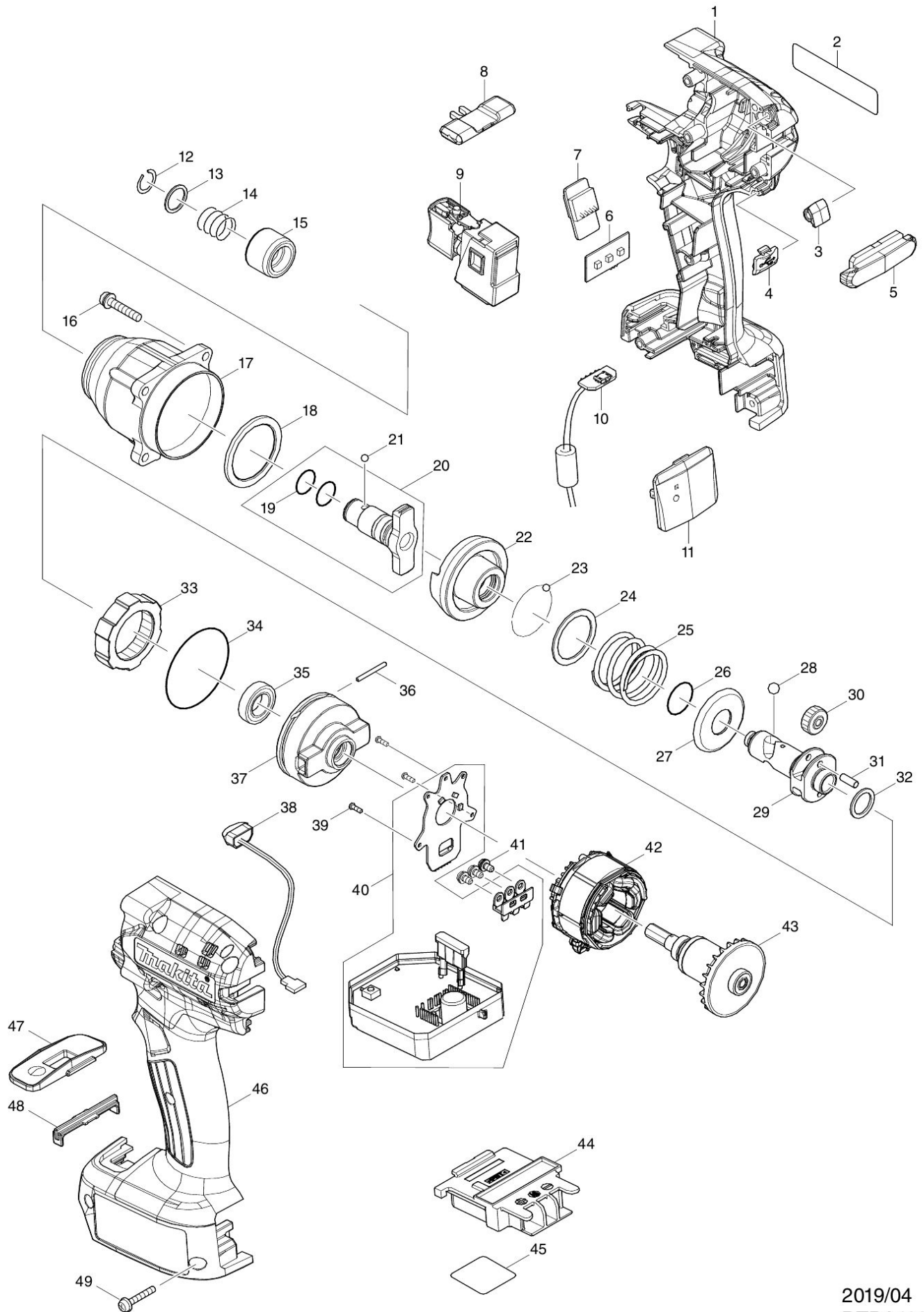

2019/04
DTDA100